

## CONSTRUCTION DETAILS

### HardieFloor® dB Flooring (27mm) Direct to Solid Timber Floor Joist

#### Option 2: Timber Framed

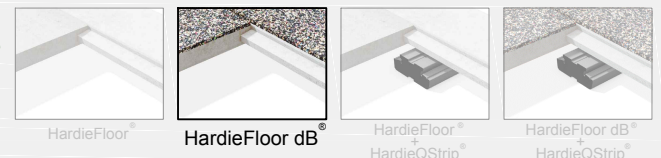

#### 1 EXTERNAL WALL JUNCTION JOISTS PARALLEL TO THE WALL

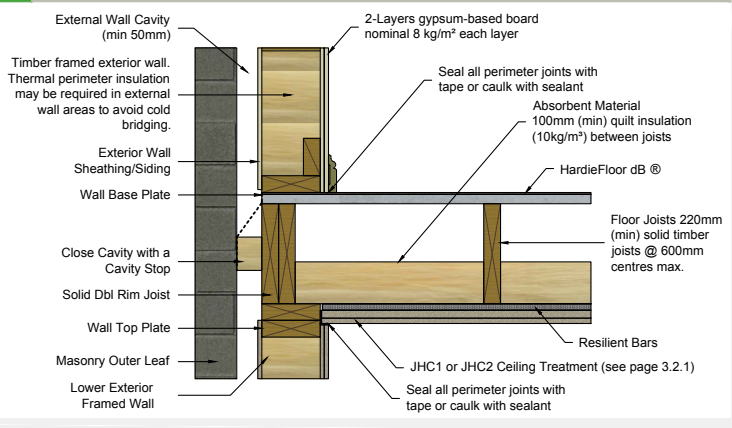

#### 2 EXTERNAL WALL JUNCTION JOISTS PERPENDICULAR TO THE WALL

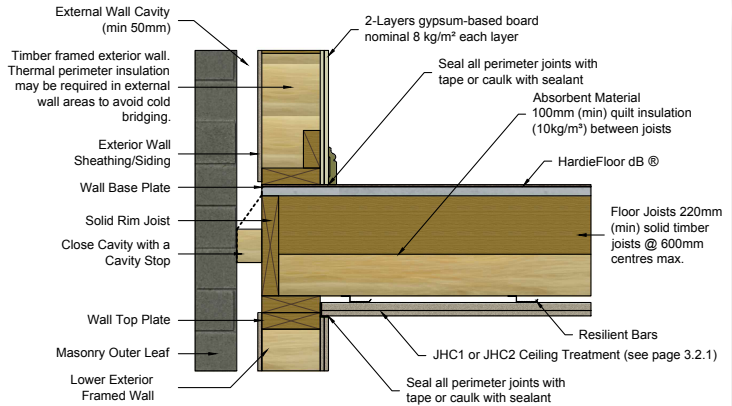

#### 3 SEPARATING WALL JUNCTION

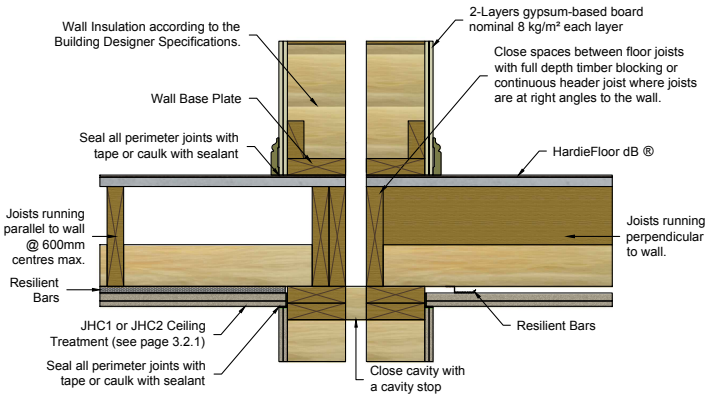

#### 4 INTERNAL WALL JUNCTION (NON LOADBEARING)

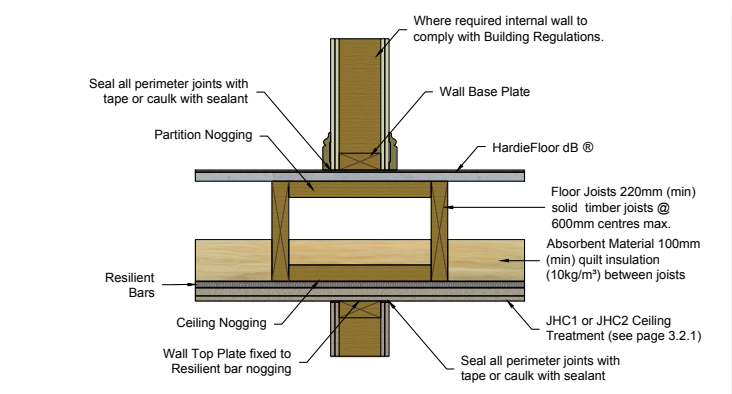

#### 5 INTERNAL WALL JUNCTION (LOADBEARING)

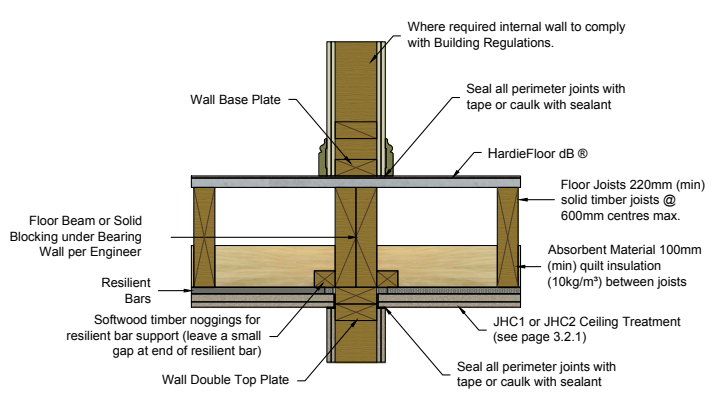

#### 6 SERVICES PIPES THROUGH SEPARATING FLOOR

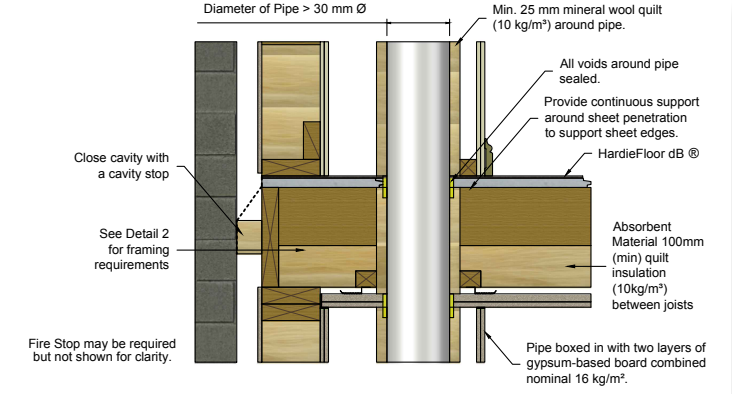

Details shown relate only to acoustic performance. The building work will also have to comply with the requirements of all other relevant parts of the Building Regulations and other relevant legislation.